



## Thule XT Kit 3028

# > Instructions

**BMW 1-Series**, 3-dr Hatchback, 07-11, 12- / \*08-

**BMW 1-Series**, 5-dr Hatchback, 04-11, 12-

**BMW 2-Series**, 2-dr Coupé, 14-

**BMW 3-Series**, 4-dr Sedan, 05-11, 12- / \*06-

**BMW 3-Series**, 5-dr Estate, 05-11

**BMW 3-Series GT**, 5-dr Hatchback, 13-

**BMW 4-Series**, 2-dr Coupé, 14-

**BMW 4-Series**, 4-dr Gran Coupé, 14-

\*North America

This kit is only for vehicles with fixpoint mounting.

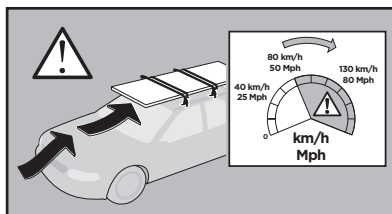
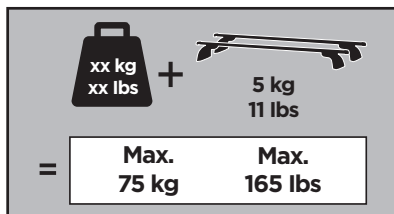
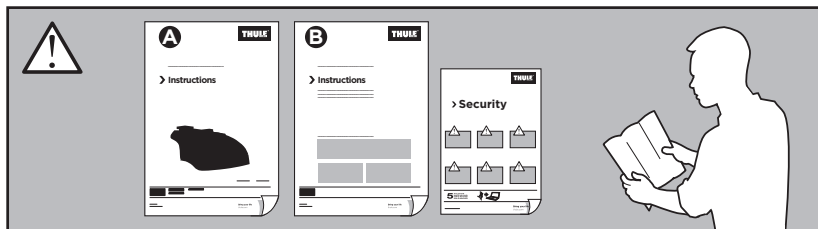

ISO 11154-E

183028

C.20141006  
509-3028-08

Bring your life  
thule.com



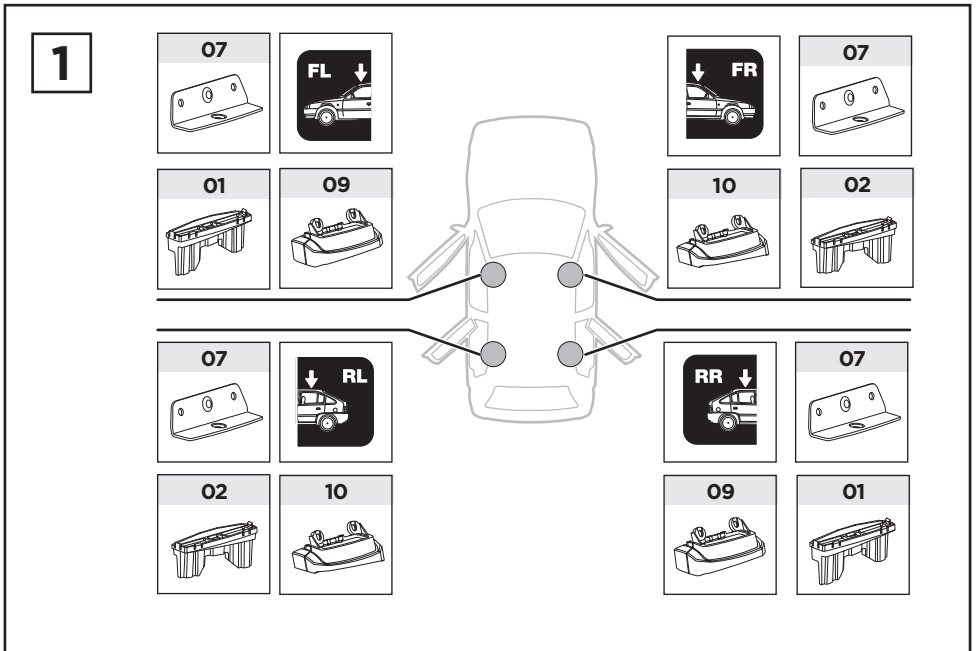
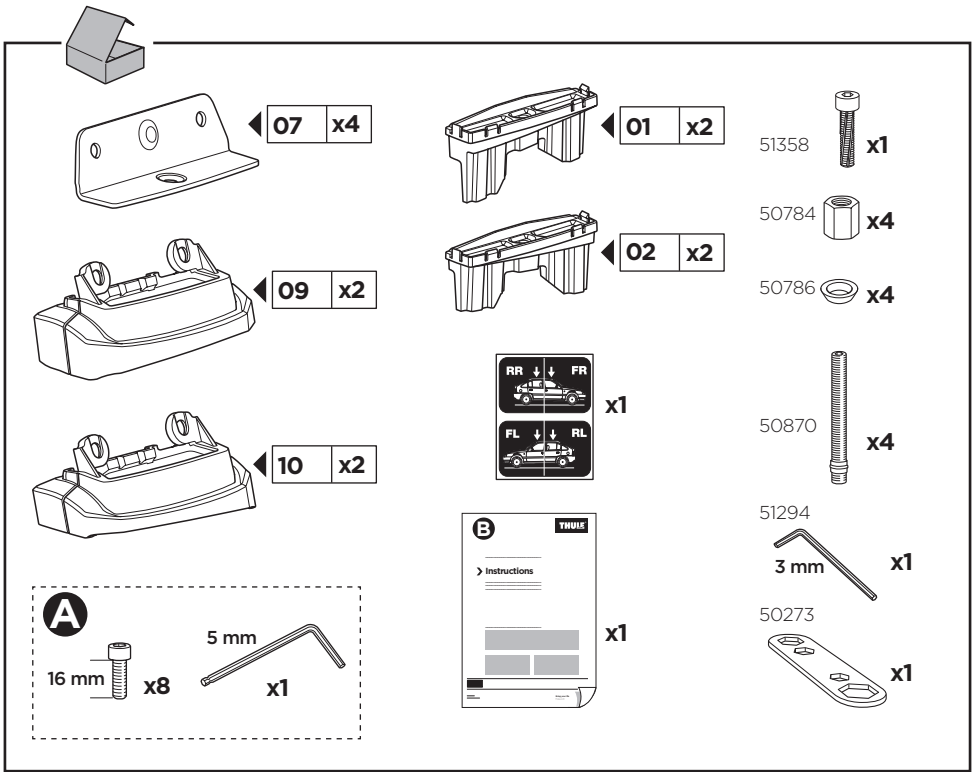

2

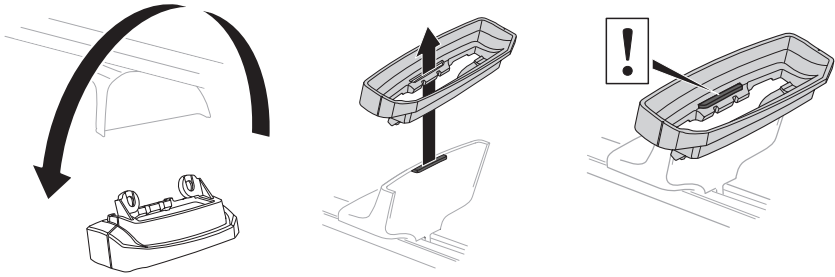

A

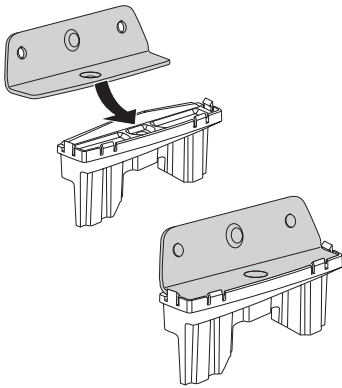

B

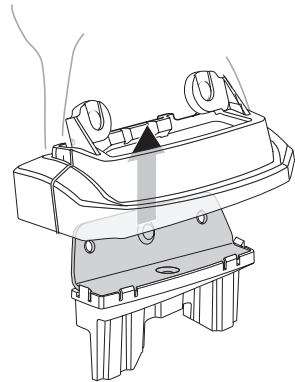

C

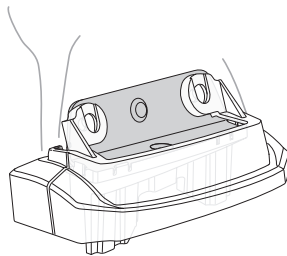

**3****A**

16 mm x8

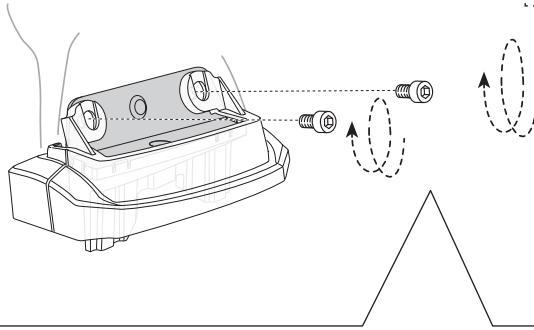

**EN** Only a few turns  
**DE** Nur wenige Umdrehungen  
**FR** Quelques tours uniquement  
**NL** Slechts enkele slagen  
**IT** Solo qualche giro  
**ES** Sólo algunas vueltas  
**PT** Noções básicas  
**SV** Endast några varv  
**DK** Kun nogle få omgange  
**NE** Bare noen få omdreininger  
**FI** Vain muutama kierros  
**ET** Ainult mõni pööre  
**LV** Tikai dažī apgriezieni  
**LT** Tik keli pasukimai  
**PL** Wystarczy kilka obrotów  
**RU** Только несколько оборотов

**UK** Лише декілька обертів  
**BG** Само няколко завъртания  
**CS** Pouze několik otáček  
**SK** Len niekoľko otáčok  
**SL** Le nekaj obratov  
**HR/BiH** Samo nekoliko okreta  
**RO** Doar câteva rotiri  
**HU** Csak néhány fordítás  
**EL** Μόνο λίγες περιστροφές  
**TR** Yalnızca birkaç tur

بعض دورات فقط

**AR**

רק מספר סיבובים

**HE**

**ZH** 仅几圈  
**JA** 2～3回転のみ  
**KO** 몇 번만 돌리면 됨  
**TH** เพียงสองสามรอบ

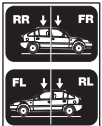
**4**

x1

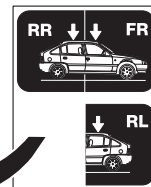
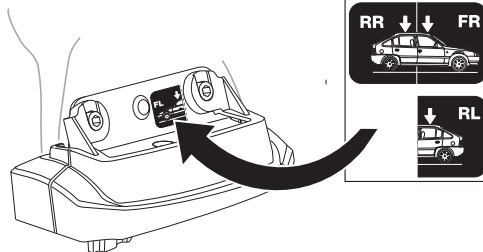

**5**



x1



x4



x4



x4

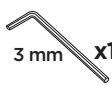

3 mm

x1

**A**

5 mm

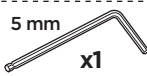

x1

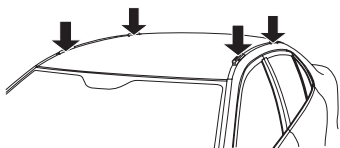

**A**

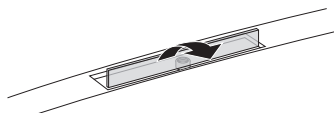

**A**

5 mm

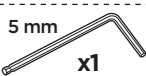

x1

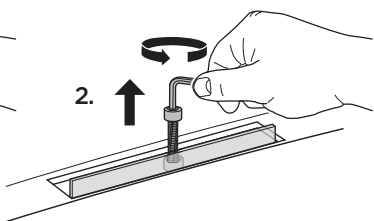
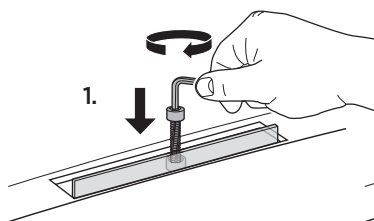

**B**

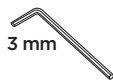

3 mm

2 Nm

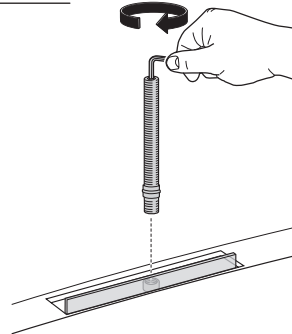
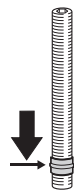

**C**

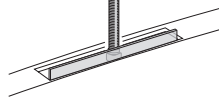
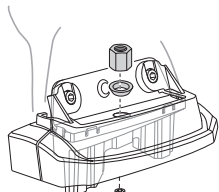

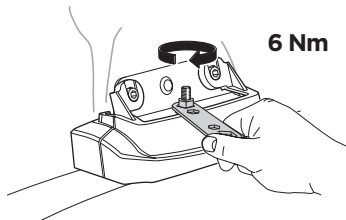
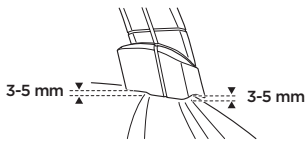

**6** A

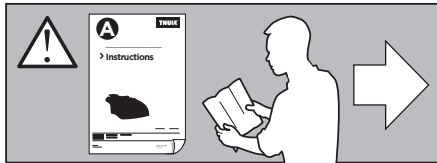
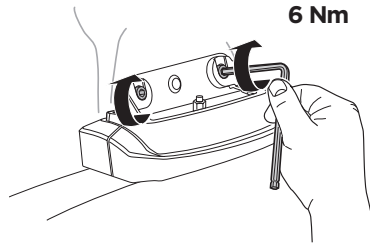
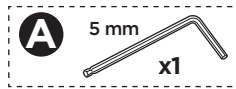

**B**



**WW** ▶  Thule Sweden AB, Box 69, 330 33 Hillerstorp, SWEDEN  
**NA** ▶  Thule Inc., 42 Silvermine Road, Seymour, Connecticut 06483, USA

 [info@thule.com](mailto:info@thule.com)  
 Phone: 800-238-2388

 [www.thule.com](http://www.thule.com)

› PART OF THULE GROUP

509-3028-08