

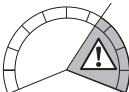

1



Kit 187119

FORD Transit, 4-dr Van, 15-



  **Max 130 km/h**
80 Mph

 +  **7 kg**
15,4 lbs = **Max: 100 kg**
/ 220 lbs

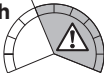
  **80 km/h**
50 Mph 

 +  **14 kg**
30,8 lbs = **Max: 150 kg**
/ 330 lbs

ISO 11154-E





This kit is only for vehicles with fixpoint mounting.

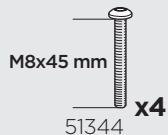
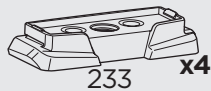
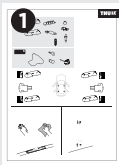

i

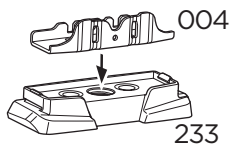
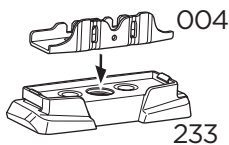
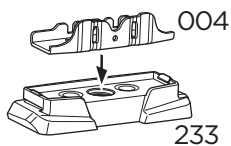
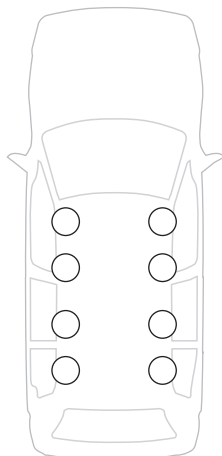
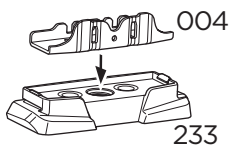

1
A

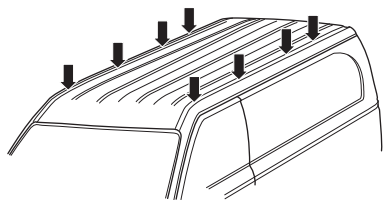

B

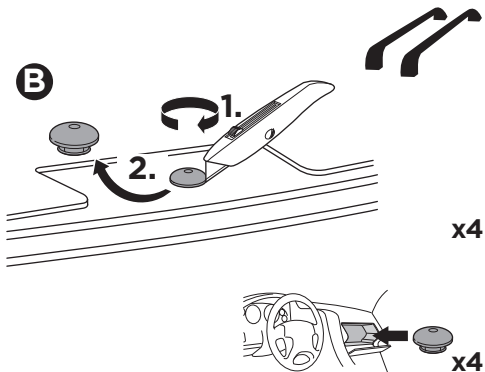

2

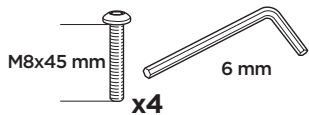

8 Nm

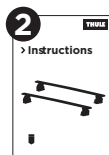
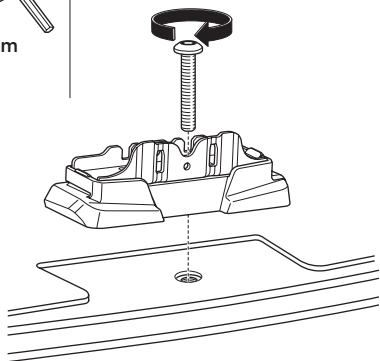



This kit is only for vehicles with fixpoint mounting.

1
KIT

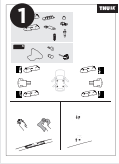

x2

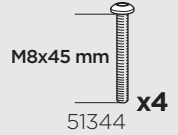
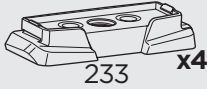

i

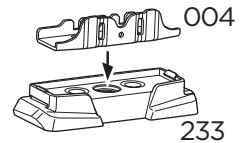
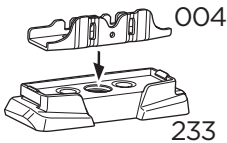
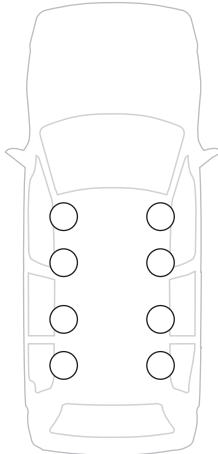
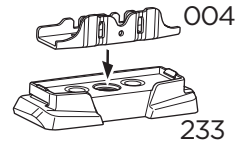
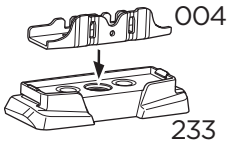

1
A

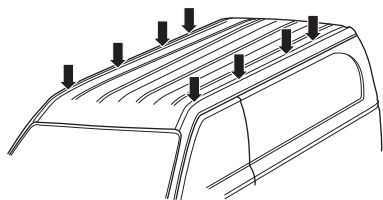

B

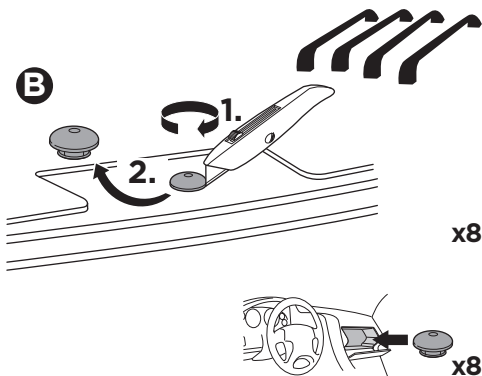

2

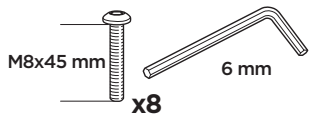

8 Nm

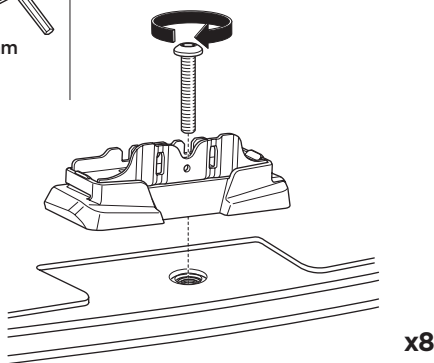

i



A

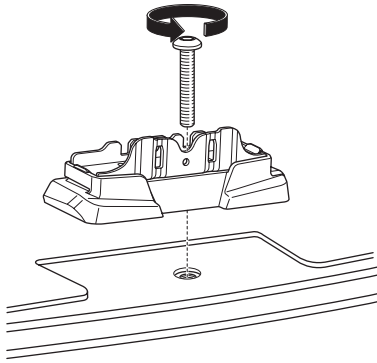

B

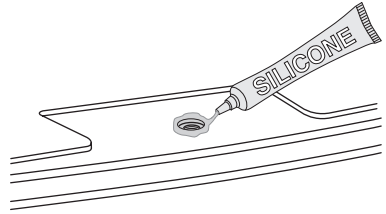

C

