

Thule Rapid System Kit 1593

> Instructions

RENAULT Fluence, 4-dr Sedan, 09–

RENAULT Megane III, 5-dr Estate, 09–16 (Without railing)

RENAULT Megane III, 5-dr Hatchback, 09–16

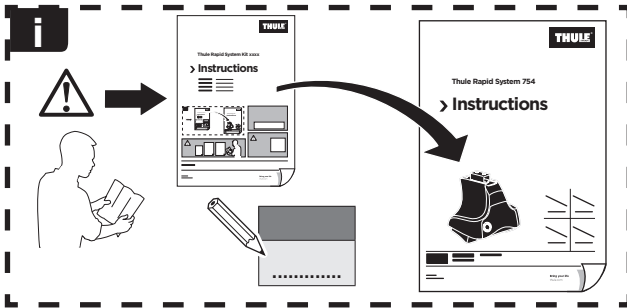

	xx kg xx lbs	+		7 kg 15,4 lbs
RENAULT Fluence	=	Max.	75 kg 165 lbs	
RENAULT Megane III	=	Max.	65 kg 143 lbs	

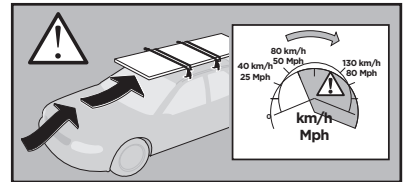
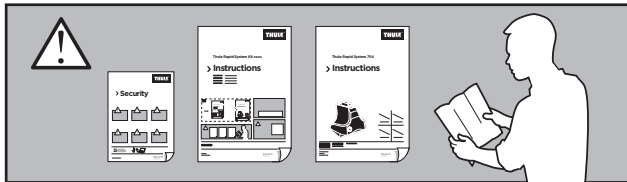

ISO 11154-E

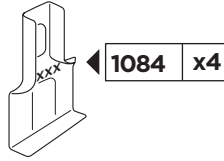
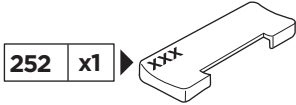
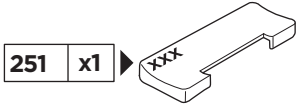
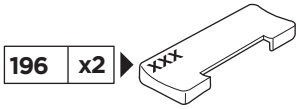

x1



x1

1

	X (scale)	X (mm)	X (inch)
RENAULT Fluence , 4-dr Sedan, 09-	37	1021	40 1/4
RENAULT Megane III , 5-dr Estate, 09-16 (Without railing)	36,5	1016	40
RENAULT Megane III , 5-dr Hatchback, 09-16	36	1011	39 3/4

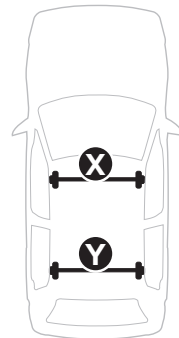
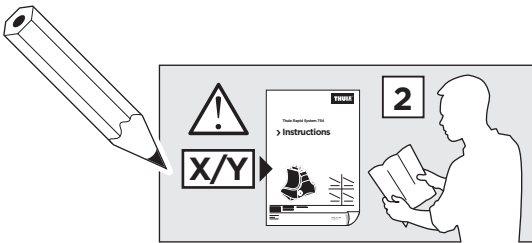

	Y (scale)	Y (mm)	Y (inch)
RENAULT Fluence , 4-dr Sedan, 09-	33	981	38 5/8
RENAULT Megane III , 5-dr Estate, 09-16 (Without railing)	32,5	976	38 3/8
RENAULT Megane III , 5-dr Hatchback, 09-16	32,5	976	38 3/8

2

RENAULT Fluence, 4-dr Sedan, 09-

RENAULT Megane III, 5-dr Estate, 09-16 (Without railing)

RENAULT Megane III, 5-dr Hatchback, 09-16

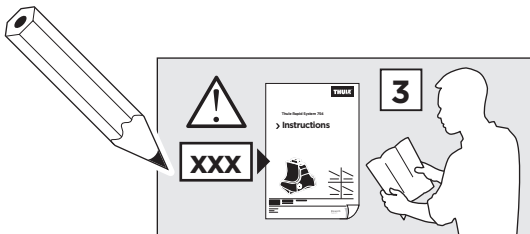
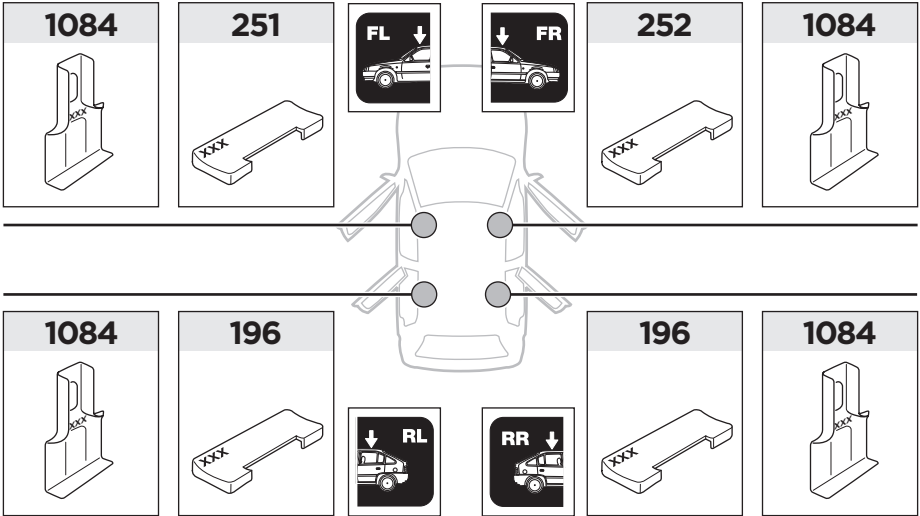

3

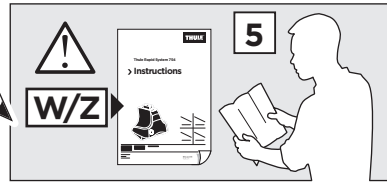

	W (mm)	Z (mm)	W (inch)	Z (inch)
RENAULT Fluence , 4-dr Sedan, 09–	110	735	4 ³ / ₈	28 ⁷ / ₈
RENAULT Megane III , 5-dr Estate, 09–16 (Without railing)	115	730	4 ¹ / ₂	28 ³ / ₄
RENAULT Megane III , 5-dr Hatchback, 09–16	120	760	4 ³ / ₄	29 ⁷ / ₈

